

FAG



Induction Heating Devices HEATER

SCHAEFFLER

Foreword

Schaeffler Technologies AG & Co. KG is a leading worldwide supplier of rolling bearings, spherical plain bearings, plain bearings, linear products, accessories specific to bearings and comprehensive maintenance products and services. It has approximately 40 000 catalogue products manufactured as standard, providing an extremely wide portfolio that gives secure coverage of applications from all 60 industrial market sectors.

Industrial Service

This Technical Product Information is aimed principally at maintenance managers and operators of plant in which rolling bearings and other rotating machine components play a critical role in determining the quality of products and processes. Those responsible for maintenance and production processes must be able to rely every day on the quality of their tools and the expertise of their service providers.

Application

Many rolling bearings are mounted with a tight fit on the shaft. In particular, larger rolling bearings can be mounted more easily if they are heated first. Induction heating is superior to the conventional methods (heating furnace, heating plate, oil bath) and is suitable for rolling bearings and other ring-shaped, ferromagnetic steel parts. It is also suitable for frequent heating.

Heating can be used on:

- complete bearings
- inner rings of cylindrical roller bearings or needle roller bearings.

Advantages

The advantages of the induction heating devices are:

- very safe operation
- high reliability
- effective, energy-efficient heating (high efficiency level)
- uniform, controlled heating
- automatic demagnetisation
- intuitive operation by means of touch-sensitive screen
- user interface in 21 languages
- software updates for the latest state of technology
- facility for documentation of every heating process.

Contents

	Page
Product overview	
Heating devices HEATER	4
Features	
Expansion through heating	5
Induction heating devices	5
Accessories and tools	5
Function	6
Functional principle	6
Operation	7
Start screen	7
Help	8
Information on the heating method	9
Setting values	10
Favourites list	11
Documenting the heating operation	12
Heating methods	13
Time control	13
Temperature control	13
Ramp control	13
Delta-T control	14
Scope of delivery and accessories for tabletop devices	15
Scope of delivery	15
Standard accessories	15
Special accessories	17
HEATER50	18
HEATER100	20
HEATER200	22
Scope of delivery and accessories for standalone devices	24
Scope of delivery	24
Standard accessories	25
Special accessories	25
HEATER400	26
HEATER800	28
HEATER1600	30

	Page
Selecting a heating device	32
FAG Heating Manager	32
Accessories	33
Heat-resistant gloves.....	33
Rolling bearing grease Arcanol MULTI3.....	33
Transport and mounting tool BEARING-MATE.....	34
Design and safety guidelines	
Hazard area	36
User manual	36
Safety of users.....	36
Protection of device	37
Protection of rolling bearings	37
Reliability of machinery.....	37
Dimension tables	
Heating devices HEATER, product range.....	38

Product overview Heating devices HEATER

Tabletop devices

HEATER50



HEATER100



HEATER200



Standalone devices

HEATER400



HEATER800



HEATER1600



Heating devices HEATER

Features	The heating devices HEATER can be used to heat rolling bearings safely and economically.
Expansion through heating	Where tight fits are to be achieved on cylindrical bearing seats, it is advisable to heat bearings for mounting. Sufficient expansion is achieved with a temperature differential of +80 °C to +100 °C. When heating the bearings, the temperature must be precisely monitored. It must not under any circumstances increase to more than +120 °C. Protective gloves should be worn while mounting the heated rolling bearings.
Induction heating devices	The induction heating devices HEATER for rolling bearings up to a mass of 1 600 kg have been improved further in terms of their performance capability and safety compared with their predecessors. They can also be used to heat sealed and greased rolling bearings. In addition to the tabletop devices HEATER50 to HEATER200, the range also includes the standalone devices HEATER400 to HEATER1600 for larger rolling bearings. The rolling bearing to be heated is either placed horizontally on the support strips or is suspended on the ledge. The contact surfaces of the ledge are ground, so there is only slight loss of power.
Accessories and tools	The functional scope of an induction heating device can be extended by the use of accessories such as temperature sensors, ledges and adapter posts. Suitable accessories such as temperature measuring devices, protective gloves and transport and mounting tools can assist significantly with the reliable thermal mounting of rolling bearings.

Heating devices HEATER

Function An induction heating device generates a strong electromagnetic field and can thus be used to heat a ferromagnetic workpiece. Due to heating, the workpiece expands, which makes mounting easier. A typical application is the heating of a rolling bearing.



Strong electromagnetic field.
Cardiac arrest due to failure of the pacemaker.
Persons fitted with a pacemaker must remain outside the hazard area. <

Functional principle The primary coil generates an electromagnetic alternating field. This electromagnetic field is transmitted via the iron core to the secondary coil, for example a rolling bearing, *Figure 1*. In the secondary coil, a high induction current at low voltage is induced.
The induction current causes rapid heating of the rolling bearing. Any parts that are not ferromagnetic, as well as the heating device itself, remain cold.
During heating, an electromagnetic field is generated. After the heating operation is stopped, the field remains in place while the workpiece is being demagnetised (max. 5 s).
The electromagnetic field is very strong directly at the heating device. The electromagnetic field becomes weaker with increasing distance from the heating device.

- ① Primary coil
- ② Secondary coil, in this case a rolling bearing
- ③ U-shaped iron core
- ④ Ledge
- ⑤ Electromagnetic field

Figure 1
Function

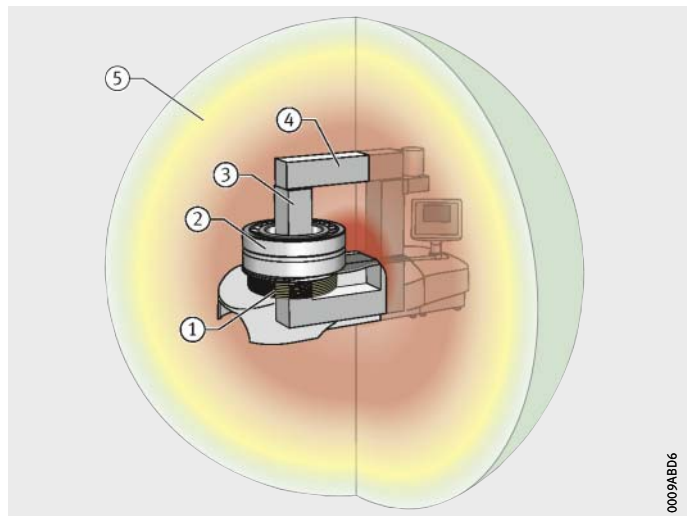

0009ABD6

Operation

Operation is by means of a touch-sensitive screen. This is oil-resistant, dustproof and waterproof. A USB connector is present below the screen, *Figure 2*. This can be used to load new firmware or other user languages.

- ① USB2.0 connection

Figure 2
Touch-sensitive screen

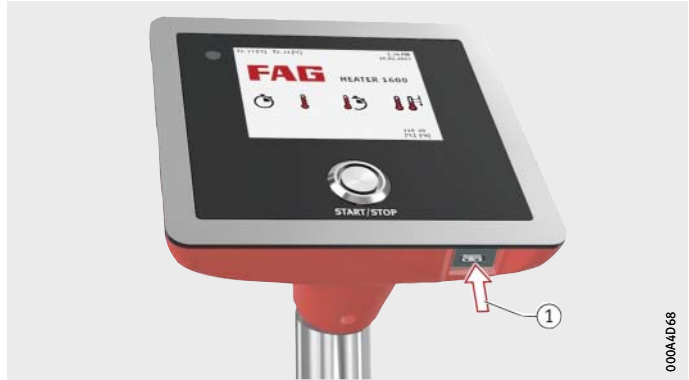

Start screen

The start screen shows the most important information at a glance. The user can immediately see which heating method is selected and what values are set. Areas that can be clicked on are shown with a white border. Symbols that are greyed out can also be clicked on, *Figure 3*.

- ① Four heating methods
- ② Set value
- ③ Clickable areas

Figure 3
Start screen

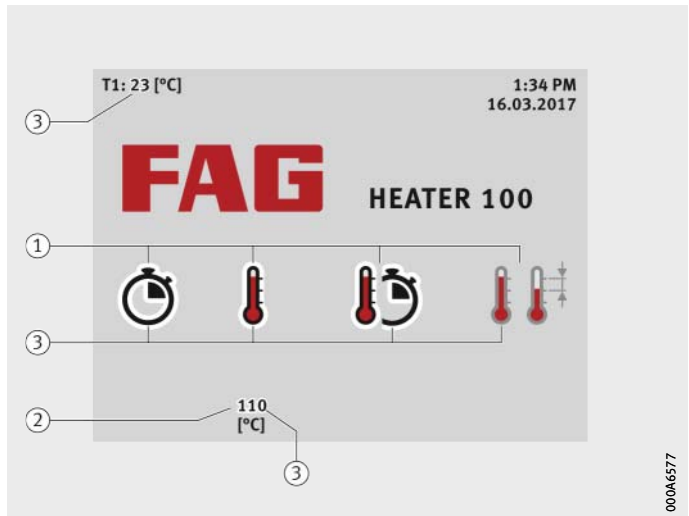

Heating devices HEATER

Help After instruction, the employee can call up information directly on the screen. If he clicks on the temperature displayed, an explanatory text will appear for T1 or T2 respectively, *Figure 4*.

An explanatory text is not sufficient in all situations. If a temperature sensor is not inserted, the symbols for three heating methods will be greyed out. If the user clicks on a greyed out symbol, a figure will show that a temperature sensor must be inserted for this heating method.

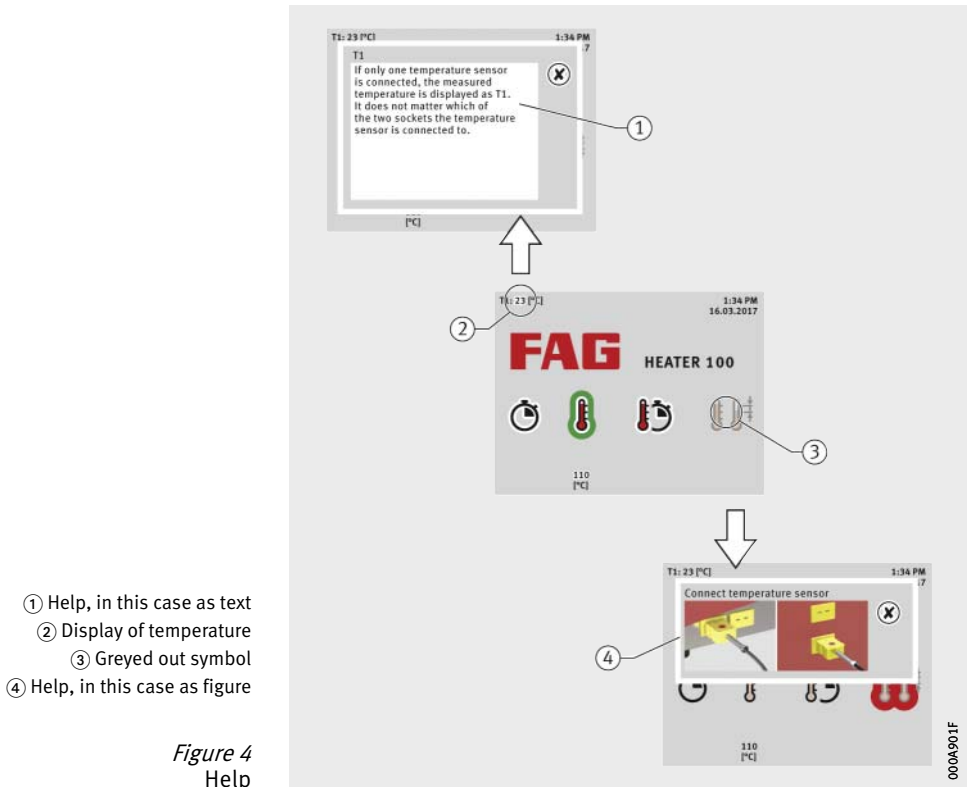

Information on the heating method

The symbols for all four heating methods are conclusive. In order to select a heating method, the user clicks on the corresponding symbol, *Figure 5*. If the user clicks again on the symbol now marked in green, he still cannot start heating this way. For safety reasons, a mechanical switch is prescribed. He will therefore be shown information on the use of [START/STOP].

If the user clicks on the name of the heating method in this window, he will see detailed information on this heating method.

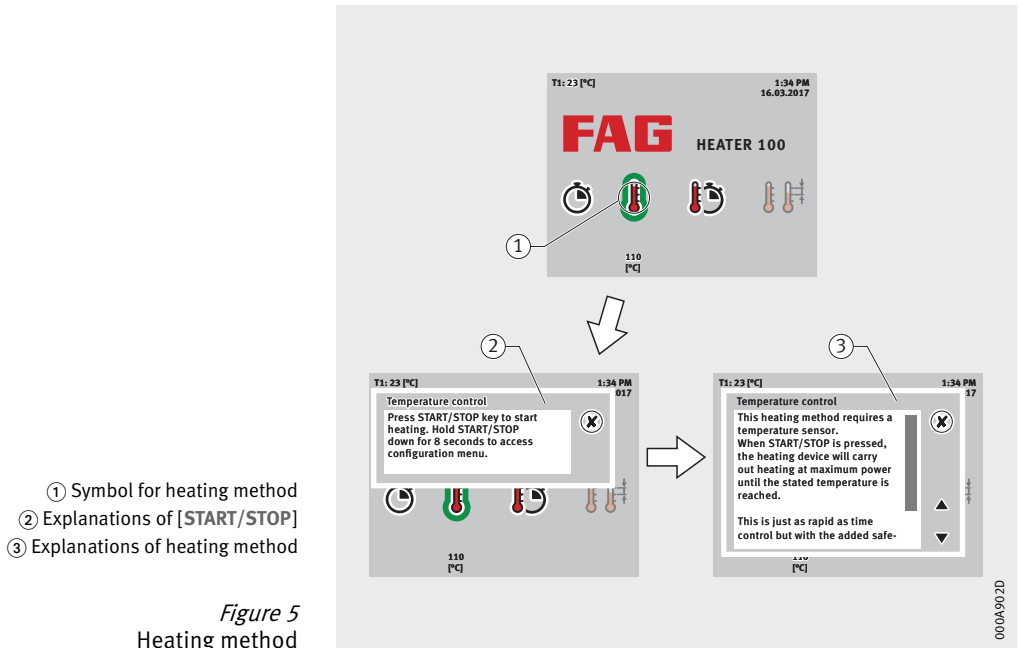

Heating devices HEATER

Setting values

Below the symbol for the currently selected heating method, the set value (time control and temperature control) or the set values (ramp control and delta-T control) are shown. If the user clicks on the value or values, this opens the setting window, *Figure 6*.

The value is increased or decreased by pressing an arrow key. The set value is updated after pressing [Apply] and displayed in the start window.

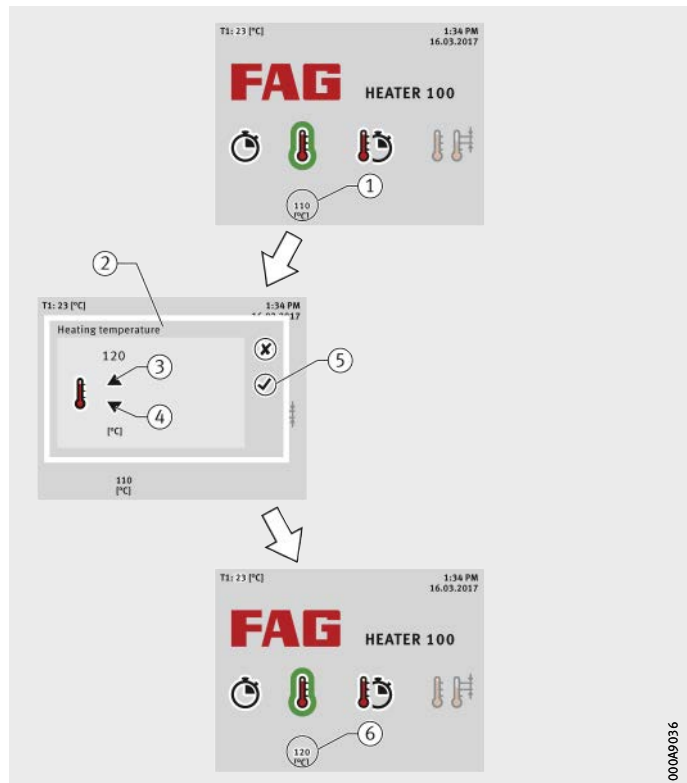

Favourites list

It is not always necessary to change values manually. The favourites list can be used to switch quickly between values. This list is created automatically and contains the most recent settings made.

Up to 10 values are stored. The current favourites can be deleted at any time by the user.

If the user clicks in the setting window on the symbol for the heating method, this opens the favourites list. After clicking on the title, the user will see an explanation of the favourites list, *Figure 7*.

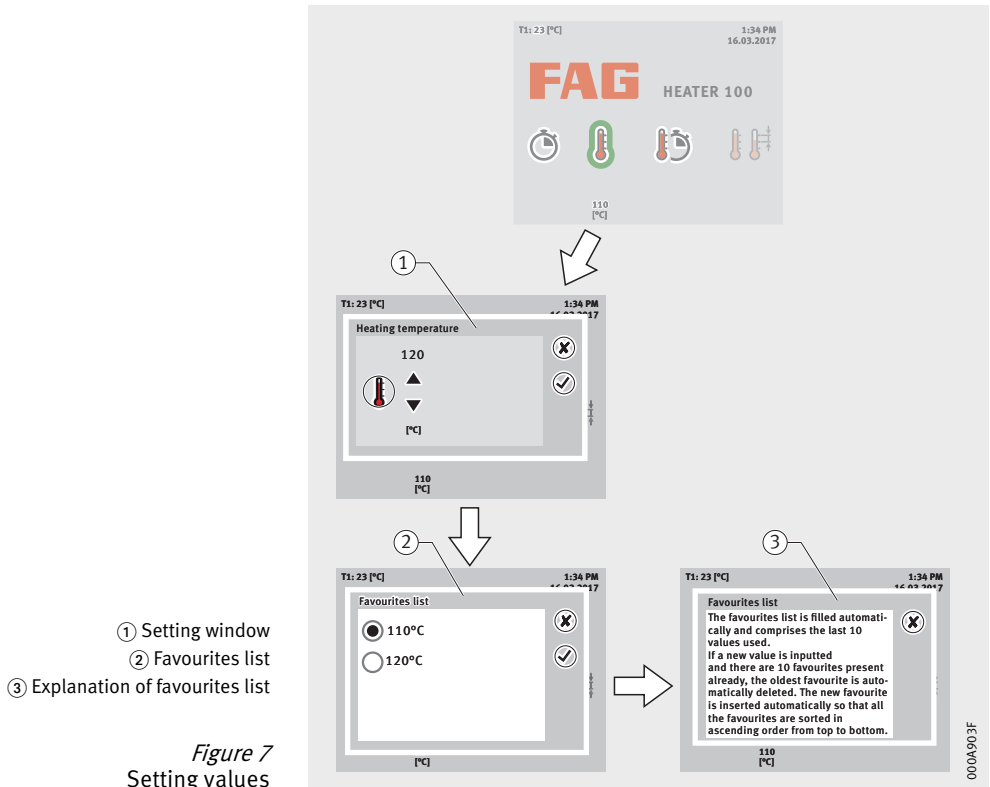

Application example

If four different rolling bearings are continually heated in the same sequence, the user first deletes the favourites list. He then inputs the values for the first rolling bearing and carries out heating. He then does the same for the second, third and fourth. Subsequently, he selects only the values saved in the favourites list.

Heating devices HEATER

Documenting the heating operation

The data for the last heating operation are saved in the device and can be displayed as a graphic. If the rolling bearing was heated with delta-T control, for example, the temperatures of the outer and inner ring will be saved, *Figure 8*.

- ① Temperature of inner ring
- ② Temperature of outer ring

Figure 8
Heating curve

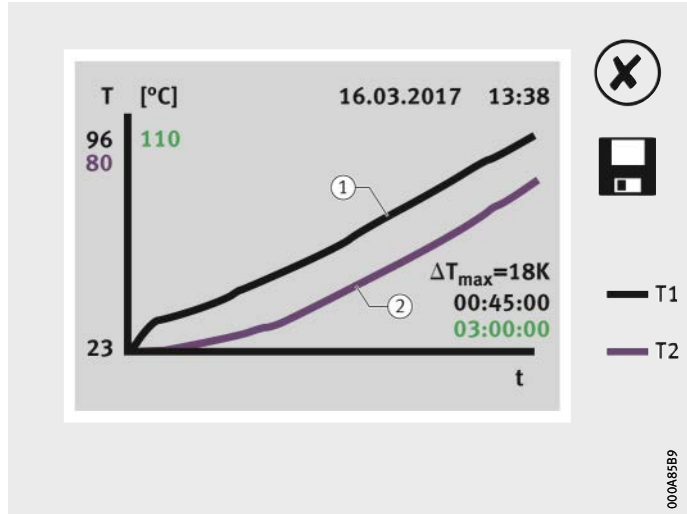

The current heating curve can be saved on a USB stick after the end of the heating operation, *Figure 9*. The data are normally saved in the .csv format and can also be displayed graphically using a normal table calculation program.

- ① Symbol [Save file]
- ② Symbol [Apply]

Figure 9
Saving the heating curve

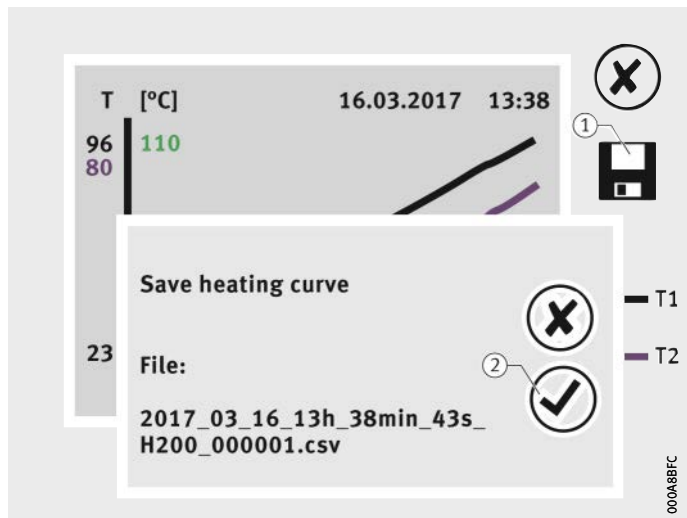

Heating methods

Each induction heating device can perform four heating methods, *Figure 10*.

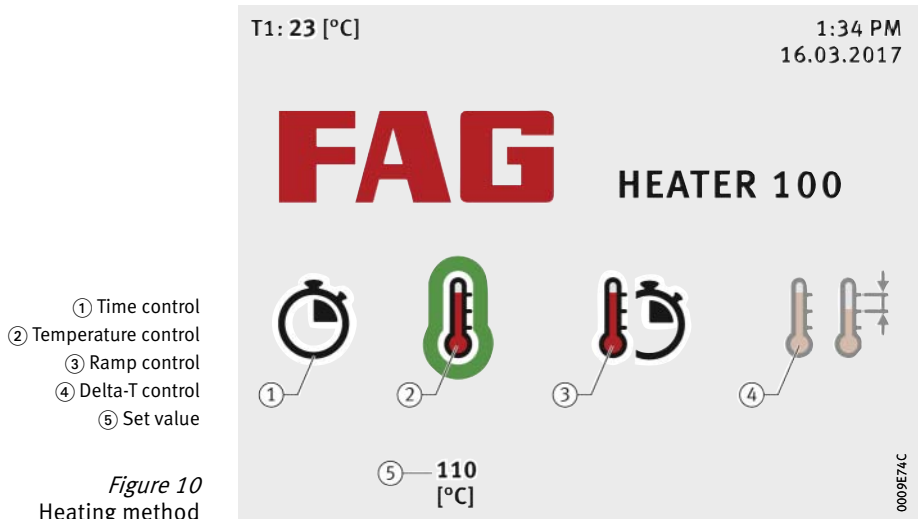

Figure 10
Heating method

Time control

The heating time is set. The advantage of time control is that the temperature sensor is not necessary. Time control is therefore particularly suitable for the rapid batch mounting of identical rolling bearings.

Temperature control

The heating temperature is set and a temperature sensor is used. Temperature control is suitable when rapid heating is required without damaging the rolling bearing.

Ramp control

The heating temperature and heating time are set and a temperature sensor is used. The controller checks the temperature continuously and regulates the power level. The temperature difference between the inner ring and outer ring remains small, preventing stress and damage to the raceway due to the indentation of the rolling elements.

Heating devices HEATER

Delta-T control

Delta-T control is mainly suitable for rolling bearings with reduced internal clearance. With this control method, damage to the bearing can be avoided. In order to prevent an excessively large temperature differential between the outer and inner ring, their temperatures are continually monitored, *Figure 11*.

Two temperature sensors are connected and attached to the outer ring and inner ring. The user inputs the heating temperature and the maximum permissible temperature differential.

When the heating operation is started, the device begins a calculation cycle. After the calculation period, actual heating then starts. The heating device continually checks the temperature differential and reduces the power if the temperature differential approaches the maximum temperature differential very quickly. If the limit value is reached, the device regulates the power to 0%, even if the heating temperature has not yet been reached. If the value undershoots the limit value by a sufficient amount, the heating device will regulate the power upwards again and the heating operation will be continued. This prevents stresses and raceway damage due to rolling element indentation.

- ① Initial temperature
- ② Heating temperature
- ③ Temperature of inner ring
- ④ Temperature of outer ring
- ⑤ Heating time
- ⑥ Calculation period
- ⑦ Maximum temperature differential

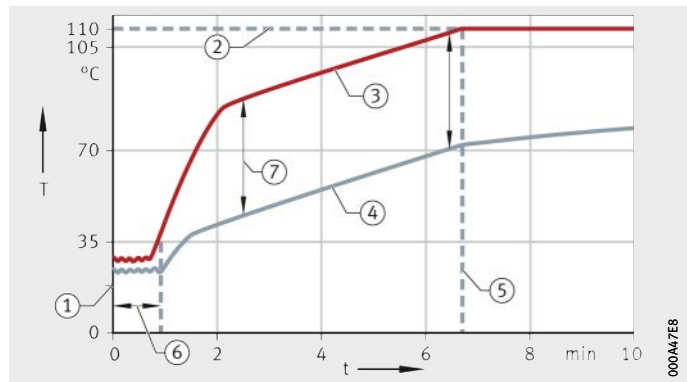

Figure 11
Delta-T control

Scope of delivery and accessories for tabletop devices

Scope of delivery

The scope of delivery comprises the heating device, standard accessories and user manual. In order to expand the functional scope of a device, special accessories are available.

The scope of delivery comprises the heating device, standard accessories and user manual, *Figure 12*.

- ① Heating device
- ② Slewing ledge 70
- ③ Temperature sensor, magnetic
- ④ Lifting tool
- ⑤ User manual
- ⑥ Grease

Figure 12
Scope of delivery
Tabletop device HEATER100



Standard accessories

The standard accessories for a tabletop device comprise a ledge, grease, one or two (in the case of HEATER200) temperature sensors and the appropriate lifting tool for transport.

Support ledge

The HEATER50 is supplied with a support ledge. The ledge supplied as a standard accessory has the same cross-section as the U-shaped core and allows maximum power to be achieved.

Slewing ledge

The heating devices HEATER100 and HEATER200 are supplied with a slewing ledge. This has the same cross-section as the U-shaped core and allows maximum power to be achieved.

Grease

The contact surfaces of the ledges are greased in order to reduce wear and vibrations. A suitable grease is included in the scope of delivery.

Heating devices HEATER

Temperature sensors

Two temperature sensors can be connected to each induction heating device. The sensor head of the temperature sensor is magnetic and is positioned on the component. The signal is fed via the cable and plug to the heating device, *Figure 13*.

The induction heating devices HEATER50 and HEATER100 are supplied with one temperature sensor. If two temperature sensors are used, it is possible to operate the heating method with delta-T control.

- ① Sensor head
- ② Cable
- ③ Plug

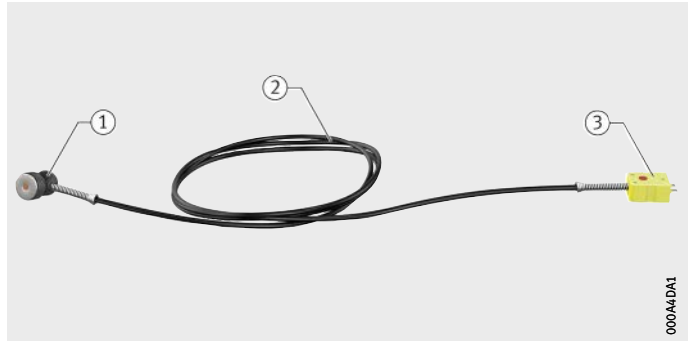

000A4DA1

Figure 13

Temperature sensor

Lifting tool

The lifting tool assists in transporting a device, *Figure 14*.

- ① Lifting tool
- ② Cotter pin
- ③ Mains connection cable

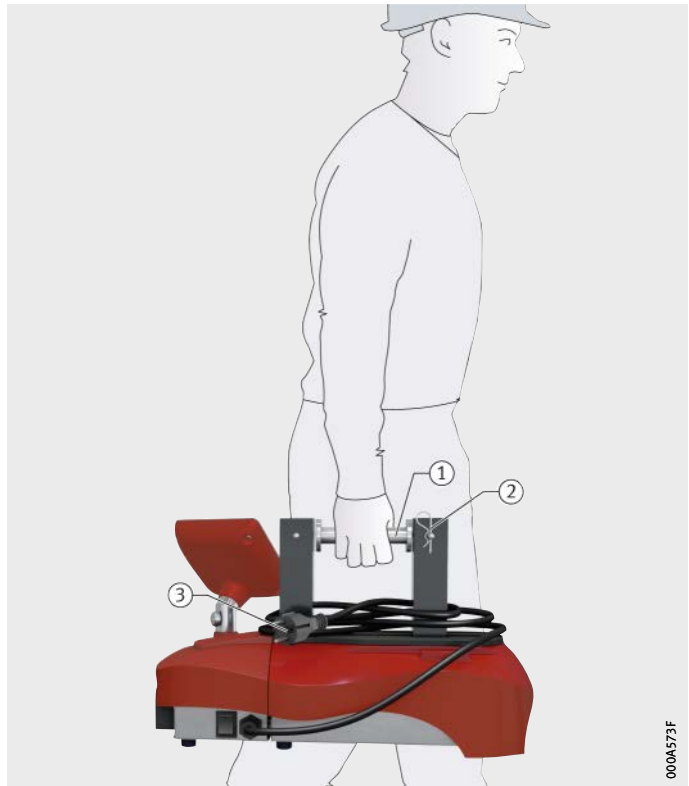

000A573F

Figure 14

Lifting tool for HEATER50

Special accessories

The functional scope of a tabletop device can be expanded by the use of special accessories.

Ledges

The ledge included in the scope of delivery has the same cross-section as the U-shaped core and allows maximum power to be achieved. In order to heat rolling bearings of a smaller inside diameter, ledges with smaller cross-sections are available.

Adapter posts

For the tabletop devices HEATER50, HEATER100 and HEATER200, adapter posts are available. These are always placed in pairs on the U-shaped core and thus increase the inner height. A support ledge is then laid on the adapter posts, *Figure 15*. With the aid of adapter posts, it is also possible to heat workpieces with a small inside diameter and a large outside diameter.

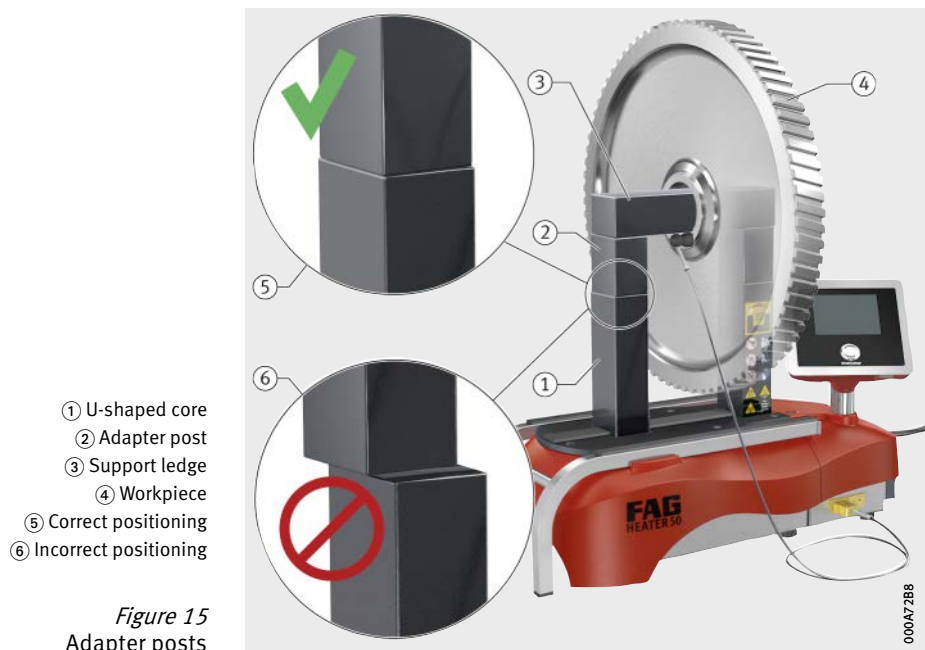

Figure 15
Adapter posts

Heating devices HEATER

HEATER50 The scope of delivery includes standard accessories, *Figure 16* upper section and table, page 19.
Special accessories are available, *Figure 16* lower section and table, page 19.



- ① Heating device
- ② Support ledge 55
- ③ Temperature sensor, magnetic
- ④ Lifting tool
- ⑤ User manual
- ⑥ Grease
- ⑦ Support ledge 10
- ⑧ Support ledge 15
- ⑨ Support ledge 20
- ⑩ Support ledge 35
- ⑪ Adapter post

Figure 16
Scope of delivery and accessories

00048570

Standard accessories

Component	Designation	Dimensions mm	d ¹⁾ mm	Mass kg
Support ledge	HEATER50.LEDGE-55	38×40×200	55	2,3
Temperature sensor	HEATER.SENSOR-500MM	–	–	0,05
Lifting tool	HEATER50.CARRY	–	–	0,35
Grease	ARCANOL-MULTI3-250G	–	–	0,28

1) Suitable for rolling bearings with minimum inside diameter as stated.

Special accessories

Component	Designation	Dimensions mm	d ¹⁾ mm	Mass kg
Support ledge	HEATER50.LEDGE-10	7×7×200	10	0,1
	HEATER50.LEDGE-15	10×10×200	15	0,2
	HEATER50.LEDGE-20	14×14×200	20	0,3
	HEATER50.LEDGE-35	24×25×200	35	0,9
Adapter posts	HEATER50.ADAPTER-75	40×50×75	–	2,2

1) Suitable for rolling bearings with minimum inside diameter as stated.

Heating devices HEATER

HEATER100 The scope of delivery includes standard accessories, *Figure 17* upper section and table, page 21.
Special accessories are available, *Figure 17* lower section and table, page 21.



- ① Heating device
- ② Slewing ledge 70
- ③ Temperature sensor, magnetic
- ④ Lifting tool
- ⑤ User manual
- ⑥ Grease
- ⑦ Support ledge 15
- ⑧ Support ledge 20
- ⑨ Support ledge 35
- ⑩ Support ledge 55
- ⑪ Adapter post

Figure 17
Scope of delivery and accessories

0004655E

Standard accessories

Component	Designation	Dimensions mm	d ¹⁾ mm	Mass kg
Slewing ledge	HEATER100.LEDGE-70	49×50×280	70	5,6
Temperature sensor	HEATER.SENSOR-500MM	–	–	0,05
Lifting tool	HEATER100.CARRY	–	–	0,05
Grease	ARCANOL-MULTI3-250G	–	–	0,28

1) Suitable for rolling bearings with minimum inside diameter as stated.

Special accessories

Component	Designation	Dimensions mm	d ¹⁾ mm	Mass kg
Support ledge	HEATER100.LEDGE-15	10×10×280	15	0,2
	HEATER100.LEDGE-20	14×14×280	20	0,4
	HEATER100.LEDGE-35	24×25×280	35	1,8
Slewing ledge	HEATER100.LEDGE-55	38×40×280	55	3,7
Adapter posts	HEATER100.ADAPTER-120	50×62×120	–	4,7

1) Suitable for rolling bearings with minimum inside diameter as stated.

Heating devices HEATER

HEATER200 The scope of delivery includes standard accessories, *Figure 18* upper section and table, page 23.

Special accessories are available, *Figure 18* lower section and table, page 23.



- ① Heating device
- ② Slewing ledge 100
- ③ Temperature sensor, magnetic
- ④ Lifting tool
- ⑤ User manual
- ⑥ Grease
- ⑦ Support ledge 20
- ⑧ Slewing ledge 30
- ⑨ Slewing ledge 40
- ⑩ Slewing ledge 55
- ⑪ Slewing ledge 70
- ⑫ Slewing ledge 85
- ⑬ Adapter post

Figure 18
Scope of delivery and accessories

000A7FA2

Standard accessories

Component	Designation	Dimensions mm	d ¹⁾ mm	Mass kg
Slewing ledge	HEATER200.LEDGE-100	70×70×350	100	13,9
Temperature sensor	HEATER.SENSOR-1000MM	–	–	0,05
Lifting tool	HEATER200.CARRY	–	–	0,5
Grease	ARCANOL-MULTI3-250G	–	–	0,28

1) Suitable for rolling bearings with minimum inside diameter as stated.

Special accessories

Component	Designation	Dimensions mm	d ¹⁾ mm	Mass kg
Support ledge	HEATER200.LEDGE-20	14×14×350	20	0,5
Slewing ledge	HEATER200.LEDGE-30	20×20×350	30	2,0
	HEATER200.LEDGE-40	28×30×350	40	3,2
	HEATER200.LEDGE-55	38×40×350	55	5,0
	HEATER200.LEDGE-70	49×50×350	70	7,4
	HEATER200.LEDGE-85	60×60×350	85	10,4
Adapter posts	HEATER200.ADAPTER-150	70×80×150	–	11,4

1) Suitable for rolling bearings with minimum inside diameter as stated.

Heating devices HEATER

Scope of delivery and accessories for standalone devices

The scope of delivery comprises the heating device, standard accessories and user manual. In order to expand the functional scope of a device, special accessories are available.

Scope of delivery

A standalone device is always supplied with a vertical ledge, grease and two temperature sensors, *Figure 19*. A lifting tool is not necessary, since a fork lift truck is required for transport. Information on fork spacing can be found in the user manual.

- ① Heating device
- ② Vertical ledge 150
- ③ Temperature sensor, magnetic
- ④ User manual
- ⑤ Grease

Figure 19
Scope of delivery
Standalone device HEATER800

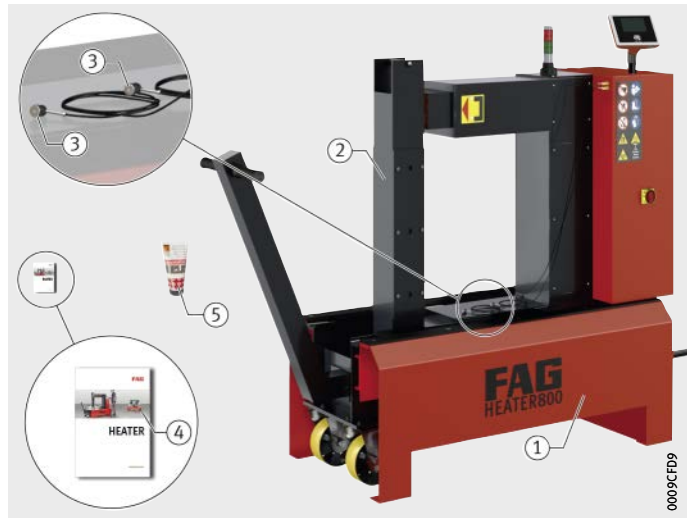

Standard accessories The standard accessories for a standalone device comprise a vertical ledge, grease and two temperature sensors.

Vertical ledge The vertical ledge supplied as a standard accessory has the same cross-section as the U-shaped core and allows maximum power to be achieved.

Grease The contact surfaces of the ledges are greased in order to reduce wear and vibrations. A suitable grease is included in the scope of delivery.

Temperature sensor Two temperature sensors can be connected to each induction heating device. The sensor head of the temperature sensor is magnetic and is positioned on the component. The signal is fed via the cable and plug to the device, *Figure 20*.

The induction heating devices HEATER50 and HEATER100 are supplied with one temperature sensor. If two temperature sensors are used, it is possible to operate the heating method with delta-T control.

- ① Sensor head
- ② Cable
- ③ Plug

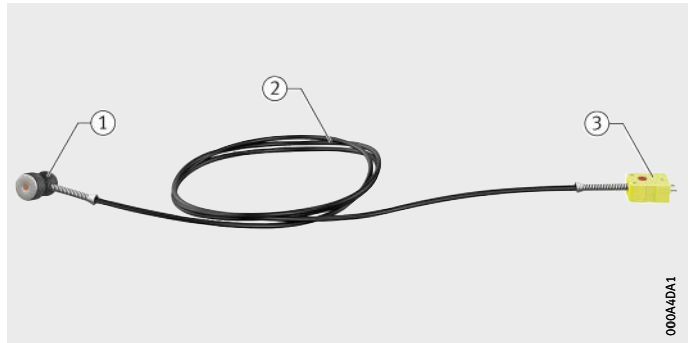

Figure 20
Temperature sensor

Special accessories Special accessories are used to expand the functional scope of a heating device.

Vertical ledges The vertical ledge included in the scope of delivery has the same cross-section as the U-shaped core and allows maximum power to be achieved. In order to heat rolling bearings of a smaller inside diameter, vertical ledges with smaller cross-sections are available.

Heating devices HEATER

HEATER400 The scope of delivery includes standard accessories, *Figure 21* upper section and table, page 27.

Special accessories are available, *Figure 21* lower section and table, page 27.



- ① Heating device
- ② Vertical ledge 120
- ③ Temperature sensor, magnetic
- ④ User manual
- ⑤ Grease
- ⑥ Vertical ledge 35
- ⑦ Vertical ledge 50
- ⑧ Vertical ledge 65
- ⑨ Vertical ledge 80
- ⑩ Vertical ledge 90
- ⑪ Vertical ledge 105

Figure 21
Scope of delivery and accessories

Standard accessories

Component	Designation	Dimensions mm	d ¹⁾ mm	Mass kg
Vertical ledge	HEATER400.LEDGE-120	80×92×490	120	28,5
Temperature sensor	HEATER.SENSOR-1000MM	–	–	0,05
Grease	ARCANOL-MULTI3-250G	–	–	0,28

1) Suitable for rolling bearings with minimum inside diameter as stated.

Special accessories

Component	Designation	Dimensions mm	d ¹⁾ mm	Mass kg
Vertical ledge	HEATER400.LEDGE-35	20×32×490	35	4
	HEATER400.LEDGE-50	30×42×490	50	6,1
	HEATER400.LEDGE-65	40×52×490	65	9
	HEATER400.LEDGE-80	50×62×490	80	12,8
	HEATER400.LEDGE-90	60×72×490	90	17,4
	HEATER400.LEDGE-105	70×82×490	105	22,6

1) Suitable for rolling bearings with minimum inside diameter as stated.

Heating devices HEATER

HEATER800 The scope of delivery includes standard accessories, *Figure 22* upper section and table, page 29.

Special accessories are available, *Figure 22* lower section and table, page 29.



- ① Heating device
- ② Vertical ledge 150
- ③ Temperature sensor, magnetic
- ④ User manual
- ⑤ Grease
- ⑥ Vertical ledge 50
- ⑦ Vertical ledge 65
- ⑧ Vertical ledge 80
- ⑨ Vertical ledge 90
- ⑩ Vertical ledge 105
- ⑪ Vertical ledge 120
- ⑫ Vertical ledge 135

Figure 22
Scope of delivery and accessories

000485A7

Standard accessories

Component	Designation	Dimensions mm	d ¹⁾ mm	Mass kg
Vertical ledge	HEATER800.LEDGE-150	100×112×750	150	65,9
Temperature sensor	HEATER.SENSOR-1500MM	–	–	0,05
Grease	ARCANOL-MULTI3-250G	–	–	0,28

1) Suitable for rolling bearings with minimum inside diameter as stated.

Special accessories

Component	Designation	Dimensions mm	d ¹⁾ mm	Mass kg
Vertical ledge	HEATER800.LEDGE-50	30×42×750	50	7,4
	HEATER800.LEDGE-65	40×52×750	65	12,2
	HEATER800.LEDGE-80	50×62×750	80	18,3
	HEATER800.LEDGE-90	60×72×750	90	25,4
	HEATER800.LEDGE-105	70×82×750	105	33,8
	HEATER800.LEDGE-120	80×92×750	120	43,3
	HEATER800.LEDGE-135	90×102×750	135	54

1) Suitable for rolling bearings with minimum inside diameter as stated.

Heating devices HEATER

HEATER1600 The scope of delivery includes standard accessories, *Figure 23* upper section and table, page 31.

Special accessories are available, *Figure 23* lower section and table, page 31.

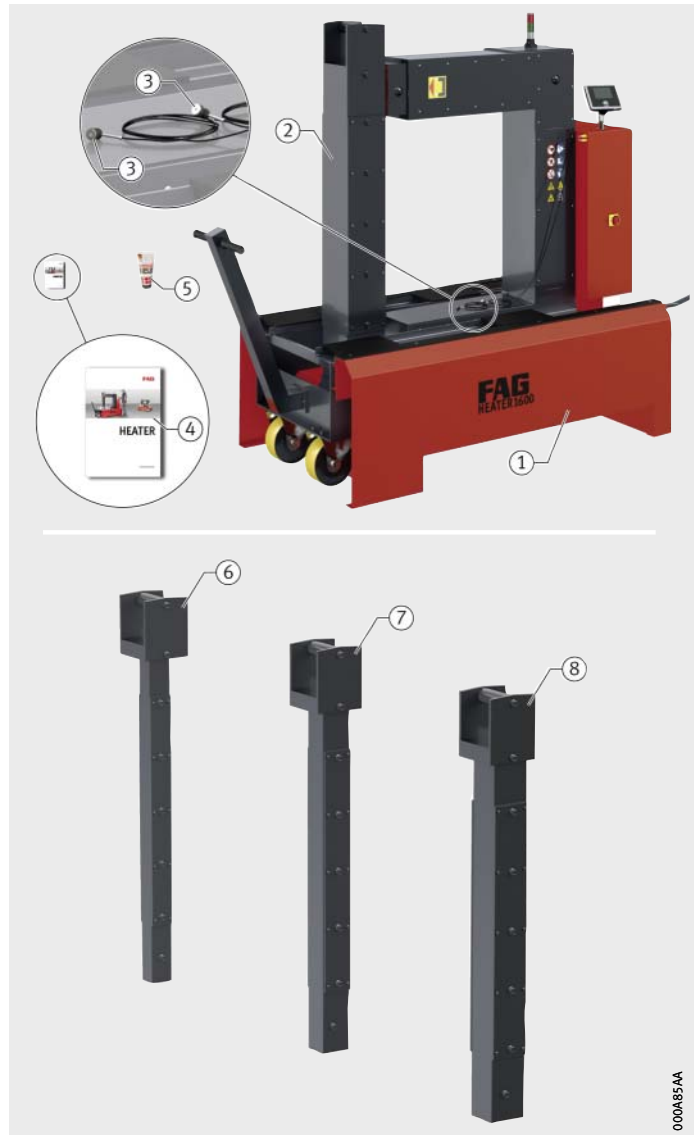

- ① Heating device
- ② Vertical ledge 220
- ③ Temperature sensor, magnetic
- ④ User manual
- ⑤ Grease
- ⑥ Vertical ledge 90
- ⑦ Vertical ledge 120
- ⑧ Vertical ledge 150

Figure 23
Scope of delivery and accessories

000085AA

Standard accessories

Component	Designation	Dimensions mm	d ¹⁾ mm	Mass kg
Vertical ledge	HEATER1600.LEDGE-220	150×162×1080	220	206,1
Temperature sensor	HEATER.SENSOR-1500MM	–	–	0,05
Grease	ARCANOL-MULTI3-250G	–	–	0,28

1) Suitable for rolling bearings with minimum inside diameter as stated.

Special accessories

Component	Designation	Dimensions mm	d ¹⁾ mm	Mass kg
Vertical ledge	HEATER1600.LEDGE-90	60×72×1080	90	36,6
	HEATER1600.LEDGE-120	80×92×1080	120	62,4
	HEATER1600.LEDGE-150	100×112×1080	150	94,9

1) Suitable for rolling bearings with minimum inside diameter as stated.

Heating devices HEATER

Selecting a heating device

Not all rolling bearings are suitable for induction heating devices. The mass and dimensions must fulfil certain values, see table.

These values must not be exceeded under any circumstances. This would overload the heating device and cause irreparable damage.

Mass and dimensions

Designation	Mass		Inside diameter	Outside diameter	Width
	Rolling bearing max. kg	Other component max. kg			
HEATER50	50	40	10	400	120
HEATER100	100	80	15	500	180
HEATER200	200	150	20	600	210
HEATER400	400	300	30	1 000	330
HEATER800	800	600	45	1 500	400
HEATER1600	1 600	1 200	85	2 000	650

FAG Heating Manager

The software FAG Heating Manager is a user-friendly tool for selection of the optimum heating device for the heating of rolling bearings.

Following input of the dimensions and mass of the rolling bearing to be heated, the suitable heating device is displayed, *Figure 24*.

On the basis of a special algorithm, the software determines the optimum heating device for the selected bearing. In addition to the preferred heating device, possible alternative devices are indicated that can also be used for the selected bearing.

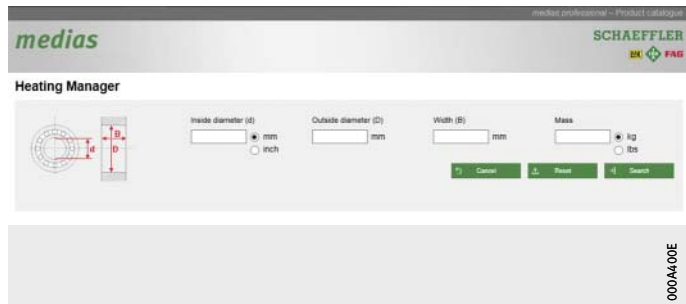

Figure 24
FAG Heating Manager

The FAG Heating Manager is available online at <http://medias.schaeffler.com>, menu item Heating Manager.

Accessories

The following accessories are recommended for thermal mounting:

- heat-resistant gloves
- rolling bearing grease
- transport and mounting tool BEARING-MATE
- infrared thermometer.

Heat-resistant gloves

Heat-resistant and oil-resistant gloves are particularly suitable for the handling of heated and greased rolling bearings in mounting or dismounting.

The gloves used should have the following characteristics:

- resistant up to +200 °C
- non-flammable
- heat-resistant even when damp
- approved to DIN EN 388 for mechanical influences and to DIN EN 407 for thermal influences
- cotton-free
- cut-resistant.

Rolling bearing grease Arcanol MULTI3

Grease on the contact surfaces of the support ledges will improve heat transfer and reduce the noise level. We recommend grease under the brand Arcanol, *Figure 25*.



Figure 25
Rolling bearing grease Arcanol

Ordering designation

The following grease has proved itself in practice and is included in the scope of delivery:

- ARCANOL-MULTI3-250G.

Heating devices HEATER

Transport and mounting tool BEARING-MATE

The BEARING-MATE is a tool for the safe, rapid and easy handling of medium-sized and large rolling bearings and comprises two handles and two steel strips, *Figure 26*. Turning the handles clamps the steel strips firmly on the outer ring of the rolling bearing. In the case of spherical roller bearings and self-aligning ball bearings, the brackets supplied are fitted in order to prevent tilting of the inner rings.

The tool and bearing are carried either by two people or a crane. If two carrying slings are used, the rolling bearing can be rotated to any position. During heating on an induction heating device, the tool remains mounted on the bearing. The steel strips expand uniformly with the bearing. Optimum tension is thus maintained.



- ① Rolling bearing
- ② BEARING-MATE
- ③ Steel strip of BEARING-MATE

Figure 26
During heating

000A659E

Three tool sizes are available to match different bearing outside diameters, see table.

Available transport and mounting tools

Designation	Bearing outside diameter		Bearing mass max. kg	Operating temperature max. °C	Tool mass kg
	min. mm	max. mm			
BEARING-MATE250-450	250	450	500	160	6,3
BEARING-MATE450-650	450	650	500	160	6,4
BEARING-MATE650-850	650	850	500	160	6,5

The scope of delivery comprises the tool, grease and short brackets, *Figure 27*. Accessories and replacement parts are available, see tables.

- ① BEARING-MATE
- ② Grease
- ③ Bracket, short

Figure 27
Scope of delivery
BEARING-MATE



Available accessories

Description	Designation
Long brackets to prevent tilting of the inner rings of self-aligning bearings (2 pieces)	BEARING-MATE.LOCKBAR270

Available replacement parts

Description	Designation
Short brackets to prevent tilting of the inner rings of self-aligning bearings (2 pieces)	BEARING-MATE.LOCKBAR170
Kit of replacement parts	BEARING-MATE.SERVICE-KIT

Heating devices HEATER

Design and safety guidelines	During operation, induction heating devices generate a magnetic field. The magnetic field can have a negative effect on implants, mobile telephones, car keys, credit cards and other data carriers as well as electronic circuits in devices.
Hazard area	For persons with artificial heart valves and pacemakers, there is a danger of death in the hazard area, so unauthorised access to the hazard area must be prevented by means of barriers.
User manual	<p>Further information on suitable operating personnel and operation can be found in the user manual. This is supplied in printed form with each device.</p> <p>The user manual is available online at www.schaeffler.de, menu item Mediathek using the search term BA42.</p>
Safety of users	<p>Induction heating devices are operated by means of a touch-sensitive screen. This screen alerts the user as soon as a magnetic field is being generated and as soon as it is completely generated.</p> <p>Protection of the user from the magnetic field:</p> <ul style="list-style-type: none">■ Access:<ul style="list-style-type: none">– The heating device must be surrounded by barriers. This can make unintentional entry to the hazard area more difficult.■ Time:<ul style="list-style-type: none">– The heating operation starts not less than 5 s after activation of the key [START/STOP], so that the user can remove himself from the magnetic field. This time can be increased in case the user requires more time to remove himself from the magnetic field.■ Optical display:<ul style="list-style-type: none">– As soon as a magnetic field is generated, this is indicated by an animation with a red rectangle.
Note!	The safe distance from the induction heating device is 2 m.

Protection of device

Protection of the heating device:

- The coil is not in the immediate vicinity of the workpiece to be heated, which prevents overheating of the heating device.
- The temperatures of the cooling element, coil and housing are continuously monitored. If the device overheats, the thermal protection system will switch it off before any component is damaged. Once the thermal protection system has been triggered, the heating device can be put back into operation once the error has been eliminated and the device has been checked.

Protection of rolling bearings

Protection of the rolling bearing:

- Through uniform heating of the rolling bearing
- Against large temperature differentials between the inner and outer ring through the use of ramp control or delta-T control. This avoids the risk of material damage such as stresses or raceway damage due to the indentation of rolling elements.

Reliability of machinery

The correct mounting of rolling bearings leads to an increase in:

- reliability of plant
- machine availability.

Heating devices HEATER



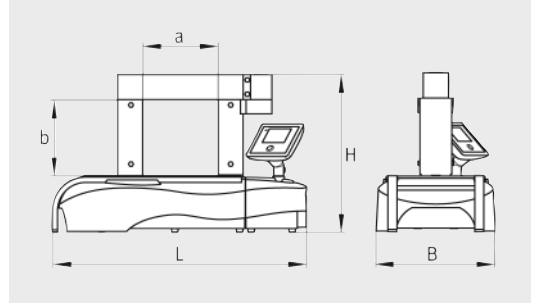

Product range



Dimension table

Characteristics		Unit	HEATER50
			
Operating voltage	U	V(AC)	110 to 230
Frequency	F	Hz	50 to 60
Power consumption	P	kVA	3
Current rating	I	A	13
Residual magnetism	H	A/cm	< 2
Operating duration	ED	%	100
Mass	m	kg	18
Length	L	mm	450
Width	B	mm	210
Height	H	mm	250
Dimension	a	mm	120
Dimension	b	mm	140
Maximum rolling bearing mass	m	kg	50
Maximum mass of other component	m	kg	40
Maximum width	b	mm	120
Minimum inside diameter ¹⁾	d	mm	55
Minimum inside diameter with accessories	d	mm	10
Maximum inside diameter (lying flat)	d	mm	300
Maximum outside diameter	D	mm	400 (with LEDGE-55)

¹⁾ When using the ledge included in the scope of delivery.

HEATER100	HEATER200	HEATER400	HEATER800	HEATER1600
				
110 to 230	400 to 575	400 to 575	400 to 575	400 to 575
50 to 60	50 to 60	50 to 60	50 to 60	50 to 60
3,7	8	12,8	25,2	40
16	20	32	63	100
< 2	< 2	< 2	< 2	< 2
100	100	100	100	100
35	86	157	280	650
540	695	850	1 080	1 500
275	330	420	500	800
310	370	950	1 250	1 600
180	210	300	430	690
180	210	330	490	700
100	200	400	800	1 600
80	150	300	600	1 200
180	210	330	400	650
70	100	120	150	220
15	20	35	50	90
400	500	900	1 400	1 900
500 (with LEDGE-70)	600 (with LEDGE-100)	1 000 (with LEDGE-120)	1 500 (with LEDGE-150)	2 000 (with LEDGE-220)

**Schaeffler Technologies
AG & Co. KG**

Postfach 1260
97419 Schweinfurt
Germany

Georg-Schäfer-Straße 30
97421 Schweinfurt
Germany

Phone +49 2407 9149-66
Fax +49 2407 9149-59
E-mail support.is@schaeffler.com
Internet www.schaeffler.com/services

Every care has been taken to ensure the correctness of the information contained in this publication but no liability can be accepted for any errors or omissions. We reserve the right to make technical changes.

© Schaeffler Technologies AG & Co. KG
Issued: 2017, June

This publication or parts thereof may not be reproduced without our permission.

TPI 200 GB-D